

COM[®] WAS-250-75/100/150 WAS-400-75/100/150

AUTOMATIC TAPING MACHINE

INSTRUCTION MANUAL

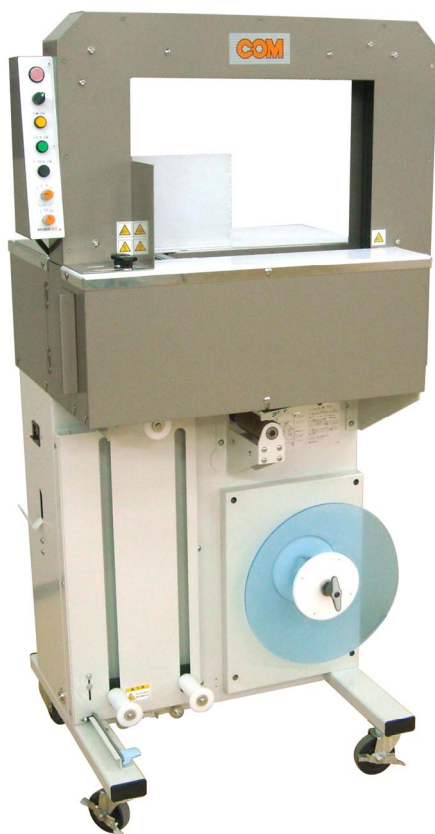

CONTENTS

1. Introduction	2
1-1. Important safety notice	2
1-2. Precautions for use and installation	2
1-3. Operating conditions.....	3
2. Name of part	4
2-1. Machine body	4
2-2. Controller	5
3. How to use this machine.....	6
3-1. Preparation	6
3-2. Tape setting.....	7
3-3. Adjustment of taping tension	11
3-4. Adjustment of banding start time	11
3-5. Taping.....	12
3-5-1. MAN mode (manual banding)	12
3-5-2. AUTO mode (automatic banding).....	12
4. Alarm signal.....	13
5. Specifications	13

1. Introduction

Read this manual carefully and understand the contents thoroughly before starting installation, operations, maintenance and checkup. Complete understanding of mechanisms and safety is essentially required.

This manual must be kept always in the machine for easy reference to it.

1-1. Important safety notice

WARNING : To prevent damage which may result in fire or shock hazard, do not expose this machine to rain or moisture.

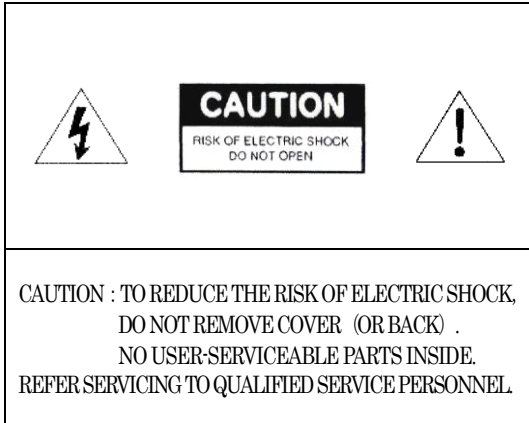

The lightning flash with arrowhead symbol, within an equilateral triangle, is intended to alert the user to the presence of uninsulated "dangerous voltage" within the product's enclosure that may be of sufficient magnitude to constitute a risk of electric shock to persons.



The exclamation point within an equilateral triangle is intended to alert the user to the presence of important operating and maintenance (servicing) instructions.

1-2. Precautions for use and installation

- Do not touch internal parts.
Be sure not to touch the internal parts. That will be cause of accident.
- Should you notice any trouble.
If any trouble occurs while you are using the machine, turn off the machine and contact your dealer.
If you continue to use the machine when there is something wrong with it, the trouble may become much worse.



Ensure that you plug the power cable supplied into a socket which is grounded. In the absence of grounding, a technical fault could be lethal.



Before carrying out service and maintenance on the inside mechanism, be sure to disconnect the power cord plug from the machine body.



Check the operating voltage before you switch on the machine. The machine will be damaged if the operating voltage does not match the line voltage.



Do not touch this part while operating the machine. The moving mechanism may cause injury and / or damage on your hand or fingers.



Heat generating unit is inside, its high temperature could cause a burn and / or injury. If you need to carry out service on the heater unit, do not touch the unit for about 10 minutes after switch off the power supply.



Install the machine on a horizontal stable position where it has a sufficient strength for supporting the machine weight.

All service and maintenance work should only be carried by a qualified service personnel.

1-3. Operating conditions

- Use the machine in places where the specified power supply with minimum fluctuation of voltage is assured.
- Locate and clamp the machine on a rigid flat floor.
- Clean the machine weekly. Especially the area around rollers is important.
- Do not run the machine in a place with high temperature, high humidity, dust, etc. (Tape jamming will be caused under such conditions.)
- The machine should be used with standard COM tapes to avoid tape sealing trouble.
- Do not fail to turn the power switch off when finishing operations.
- This manual will be revised without prior notice due to improvement or alteration of the specifications of the machine.

2. Name of part

2-1. Machine body

Rubber roller lever Rubber roller



Product sensor
Spacer Rear table



Front table

Switch box
Knob bolt
(for attachment)
Left door
Tape infeed guide
Power switch
Power cable hook
Power cable
Foot switch
connector

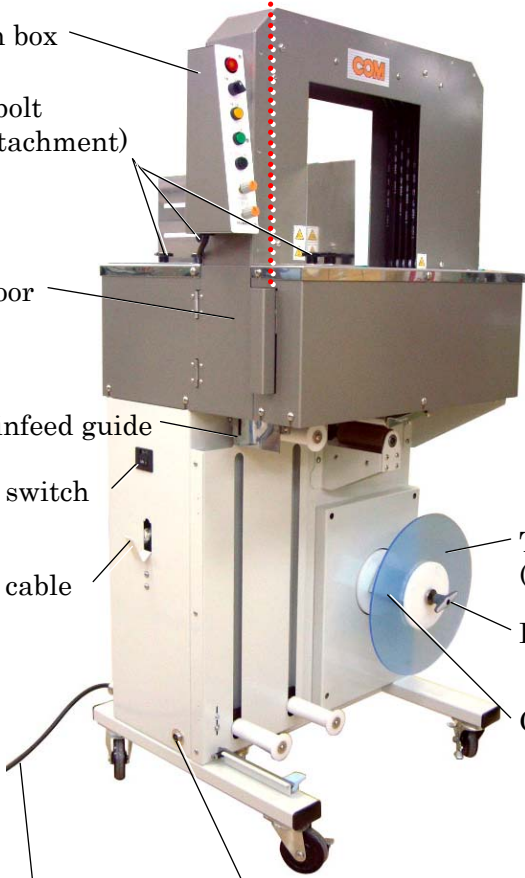

Arch guide
Attachment
Tape reel
aluminum roller
Tape roller
Tape reel
rubber roller
Dancer roller
Caster with stopper

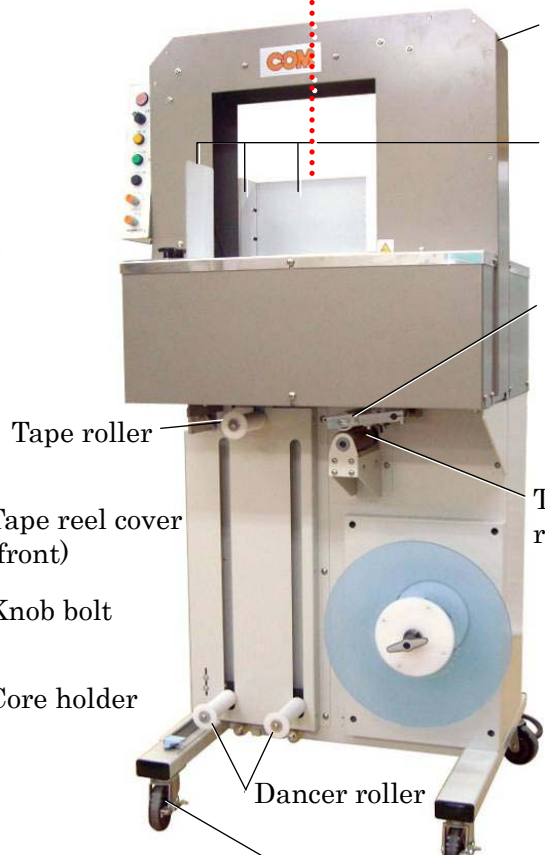

2-2. Controller

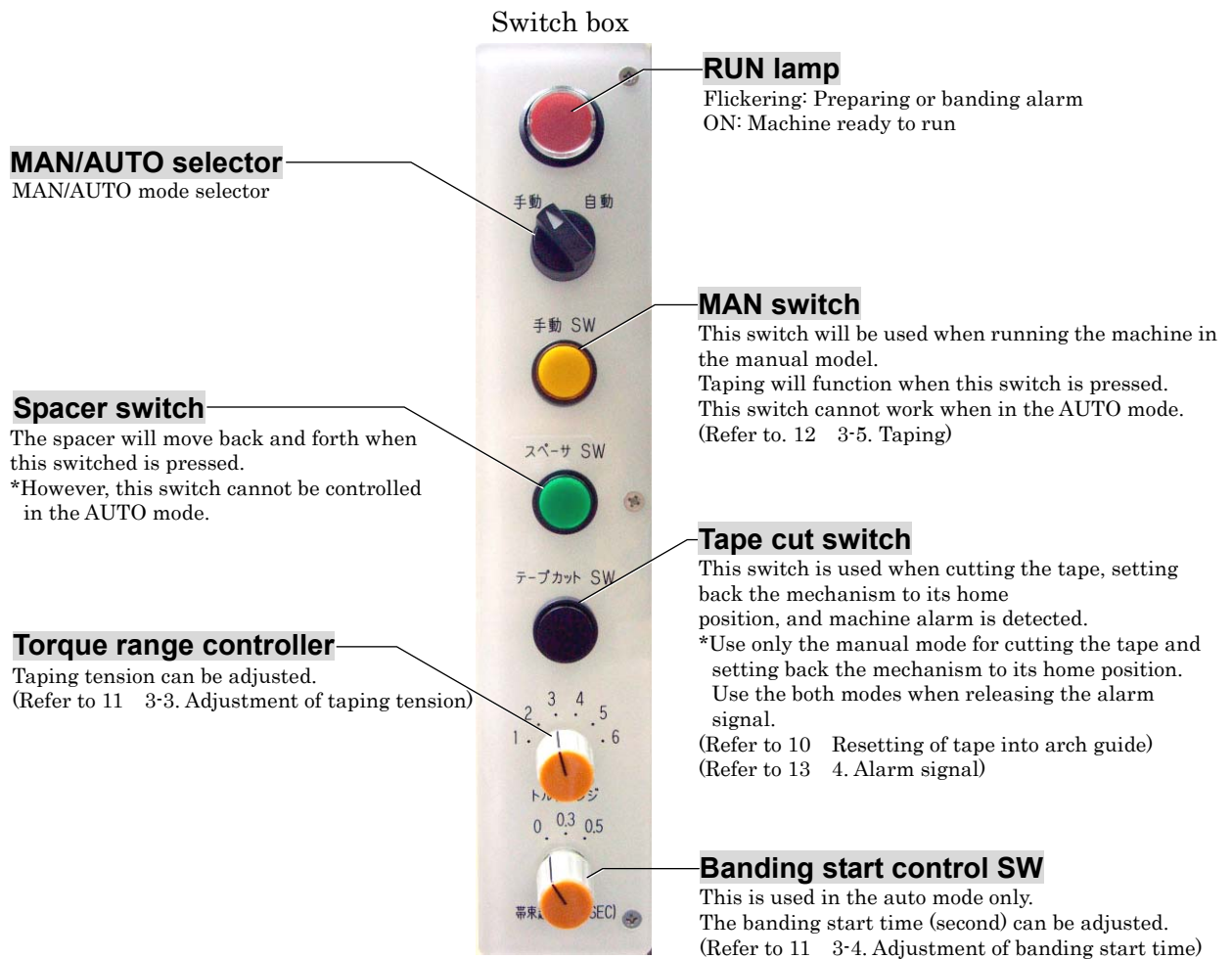

Tape set switch
The tape will be fed into the machine when this switch is pressed.
This switch cannot be used in the AUTO mode.
(Refer to 7 3-2. Tape setting)

Tape feed switch
Tape reel braking will be released when this switch is pressed.
This switch cannot be used in the AUTO mode.
(Refer to 7 3-2. Tape setting)



Power switch (breaker)



Foot switch (option)
This switch can be used in the MAN mode only.
The product in the machine will be banded when this pedal is treadled.
(Refer to 12 3-5. Taping)

3. How to use this machine

3-1. Preparation

1. Connect the power cable plug to the power plug socket.
*For using the foot switch (option), connect the foot switch cable plug to the plug socket which is located at the left side of the machine.

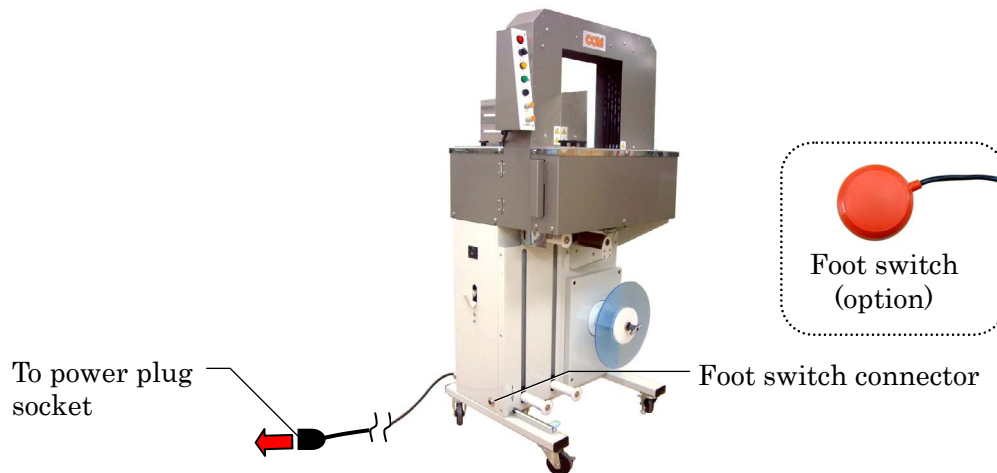

2. Set the power switch to ON.
The RUN pilot lamp will flicker.
About 30 seconds after flickering of this lamp, the heater will be ready to work lighting up this lamp. Preparation is completed now and the machine is ready to run.

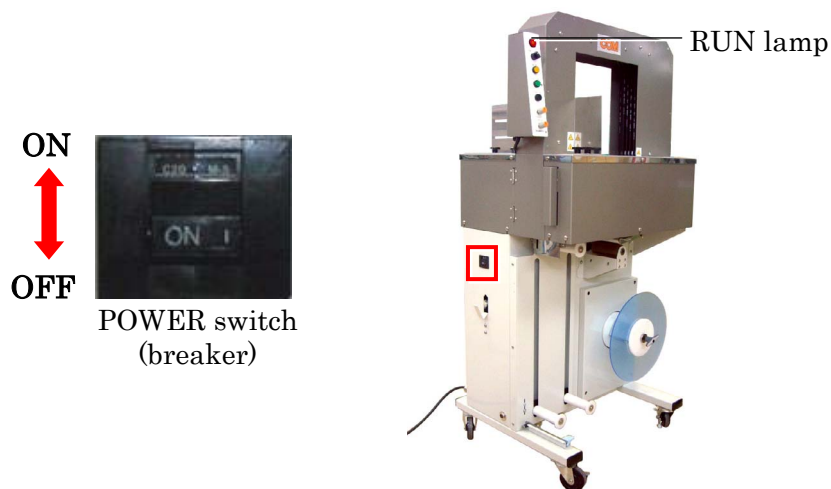

3-2. Tape setting

1. Set the MAN-AUTO selector to MAN.

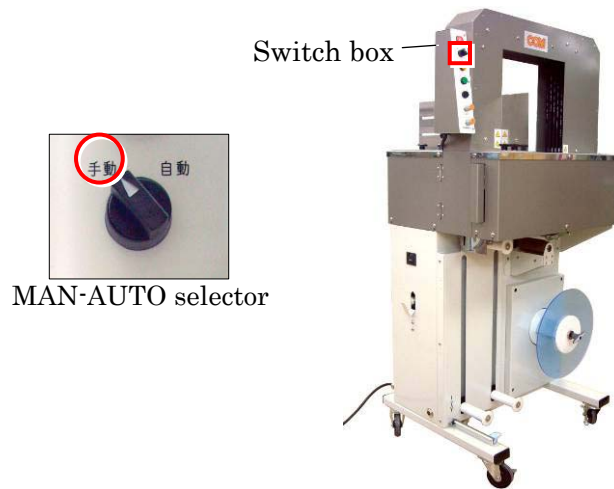

2. Turn the knob bolt counterclockwise and dismount the tape reel cover(front).

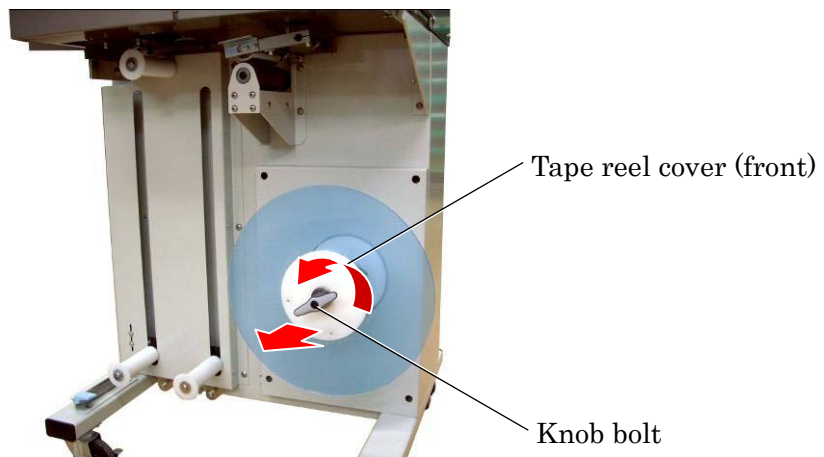

3. Set a tape reel to the core holder.
*Make sure the tape feeding direction is correct.

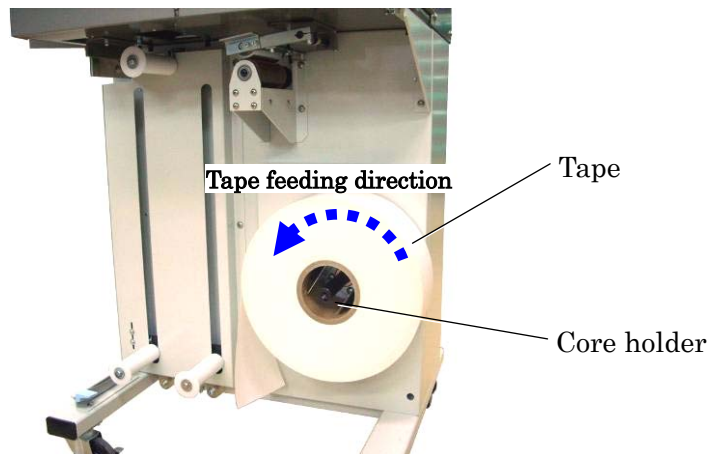

- Remount the tape reel cover (front).
Turn the knob bolt until the tape reel can be mounted securely.

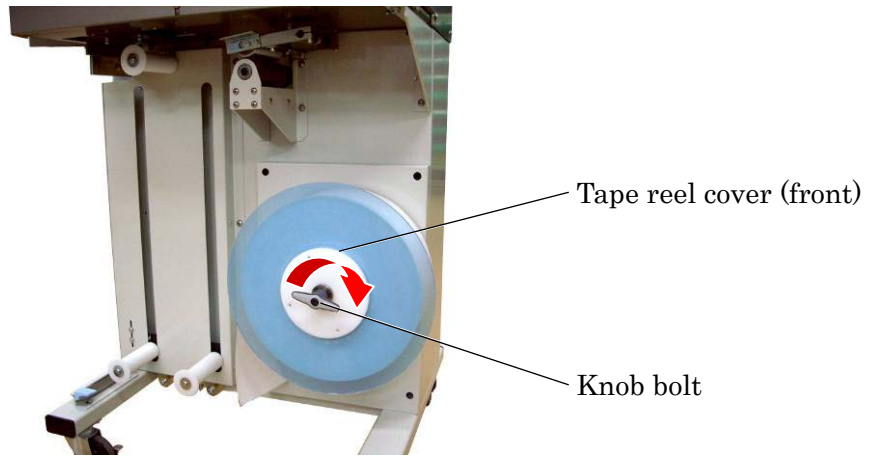

- Open the left door and press the tape feed switch.
Tape reel braking will be released.

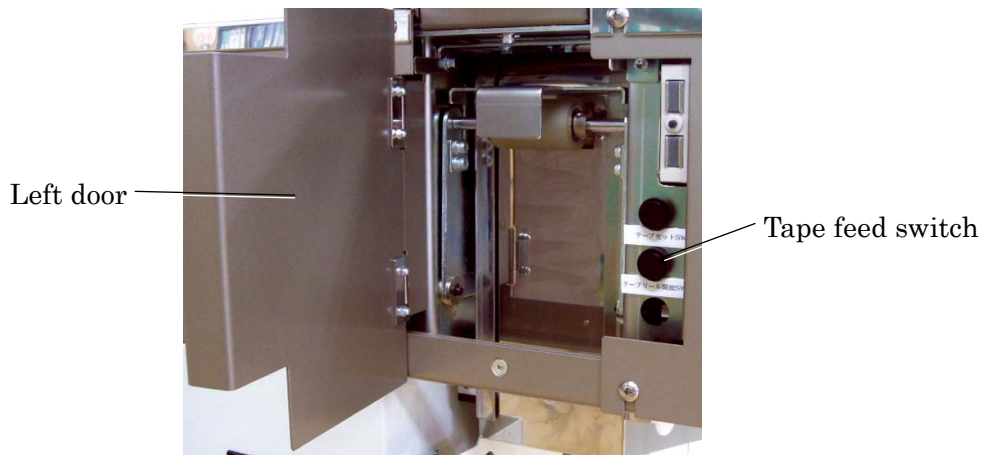

- Remove the adhesive tape which is fixing the tape head, pull the tape long enough to infeed into the machine. Move the tape reel aluminum roller up and feed the tape between this aluminum roller and the rubber roller. Then wrap the tape onto the tape roller and dancer rollers as shown below:

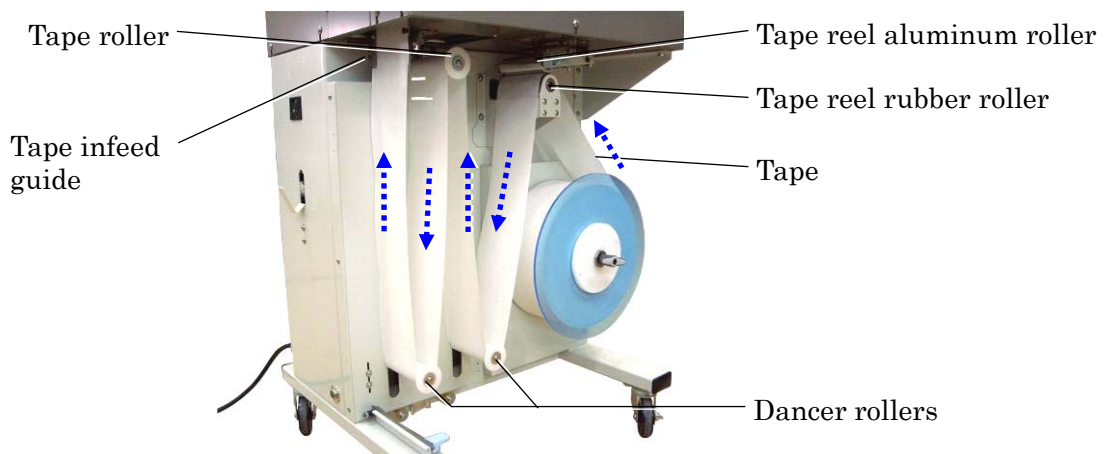

7. Insert the tape into the tape infeed guide and pull the rubber roller lever. Infeed the tape until the tape passes the rubber roller position, set back the rubber roller lever, and grip the tape.

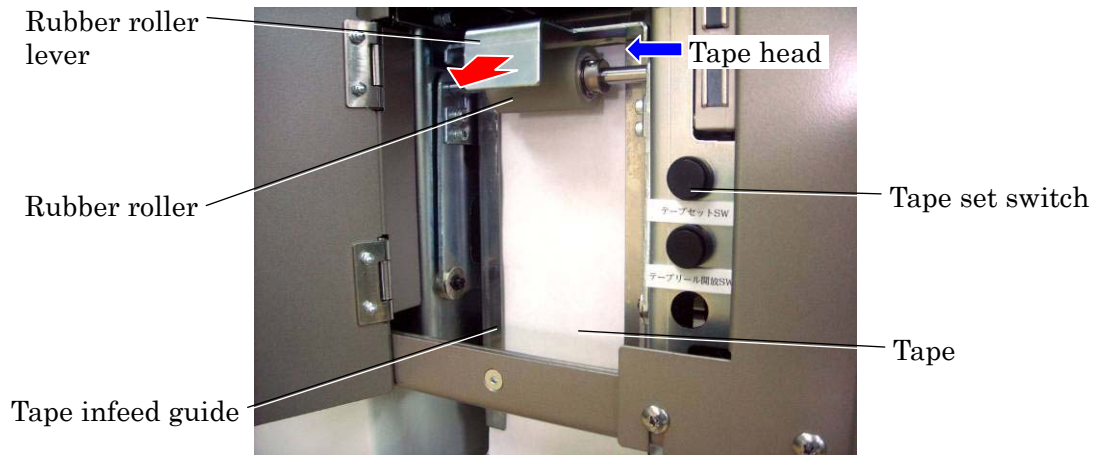

8. Press the tape set switch. The tape will be set in position.
9. Make sure the tape has been set in the normal position. (The tape is ready in the inner side of the arch guide, the tape passes below the spacer, and the tape head is located at the right side of the spacer (see the photo below). Close the left side door after checking this.

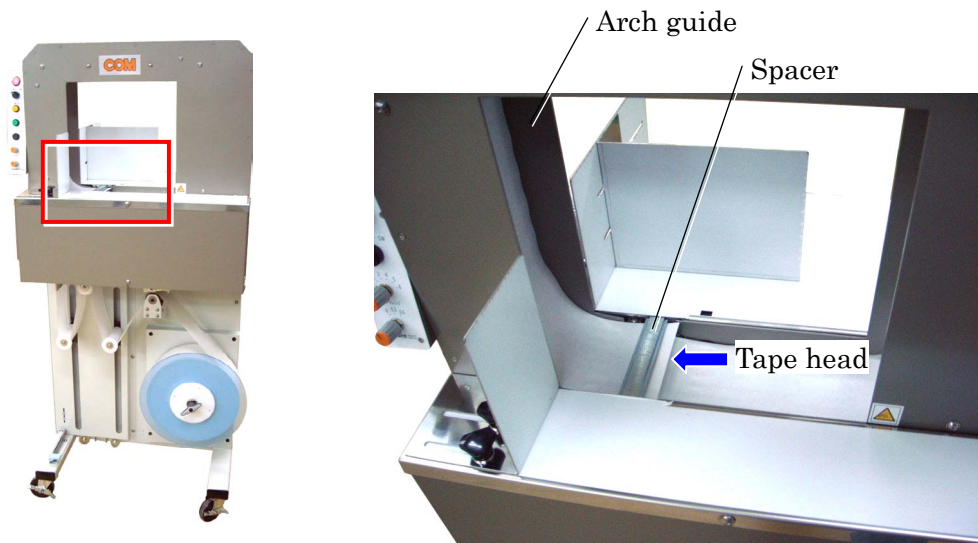

Tape setting has been completed now.

Resetting of tape into arch guide

In case that the tape cannot be set into the arch guide or resetting of tape is required, press the tape cut switch in the switch box.

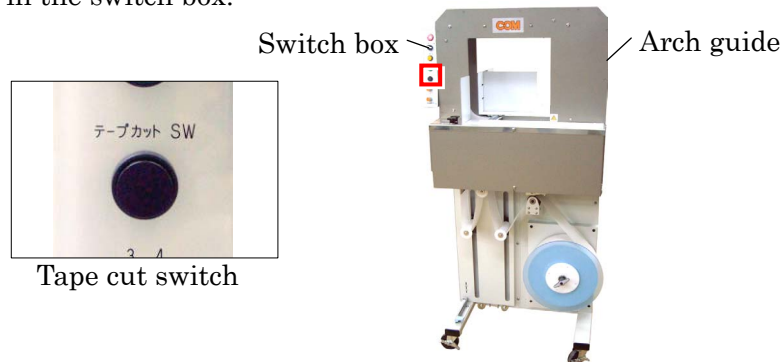

1. Resetting of tape cannot be operated

The machine mechanism is not in its home position. Press the tape cut switch. The mechanism will be set back to the home position(origin).



Origin (Spacer is ready in this position.)

2. In case that the tape has not been set in the correct way

Pull the tape head and press the tape cut switch. Then the tape will be cut and set in the machine in the fair mode.



⚠ The spacer, heater assy and clamp assy are ready to operate. Carefully pull the tape so that your hand cannot be caught in these mechanisms. The heater is hot (in a high temperature). Do not touch it so that your fingers cannot be burnt.

3-3. Adjustment of taping tension

Taping tension can be adjusted depending on the product to be banded using the torque range controller. Tension will increase when it is turned clockwise while it will decrease when this controller is turned counterclockwise. This tension can be adjusted to six levels.

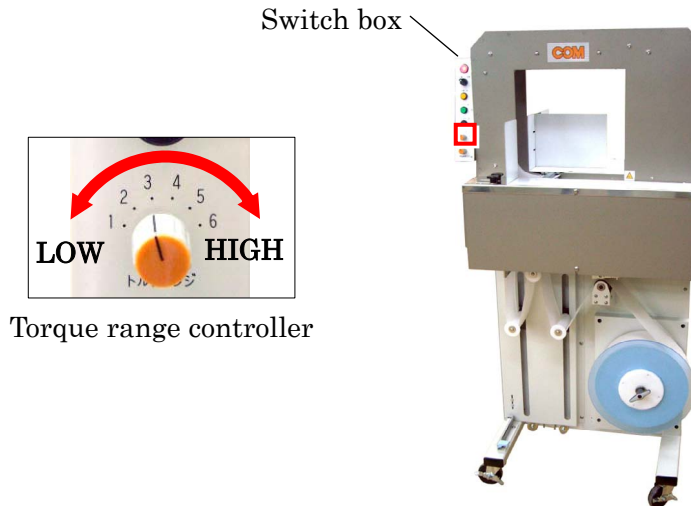

3-4. Adjustment of banding start time

Banding start time (time from workpiece detection till banding start) can be controlled by manipulating the banding start time setting switch, which is located inside the switch box.

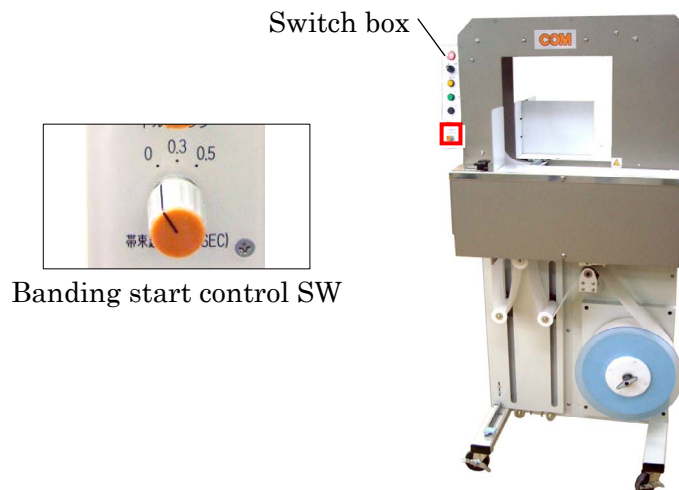

3-5. Taping

Set the attachments (product locator) in position according to the size of product or the place to be banded. The product to be banded must be placed above the spacer and the product sensor.

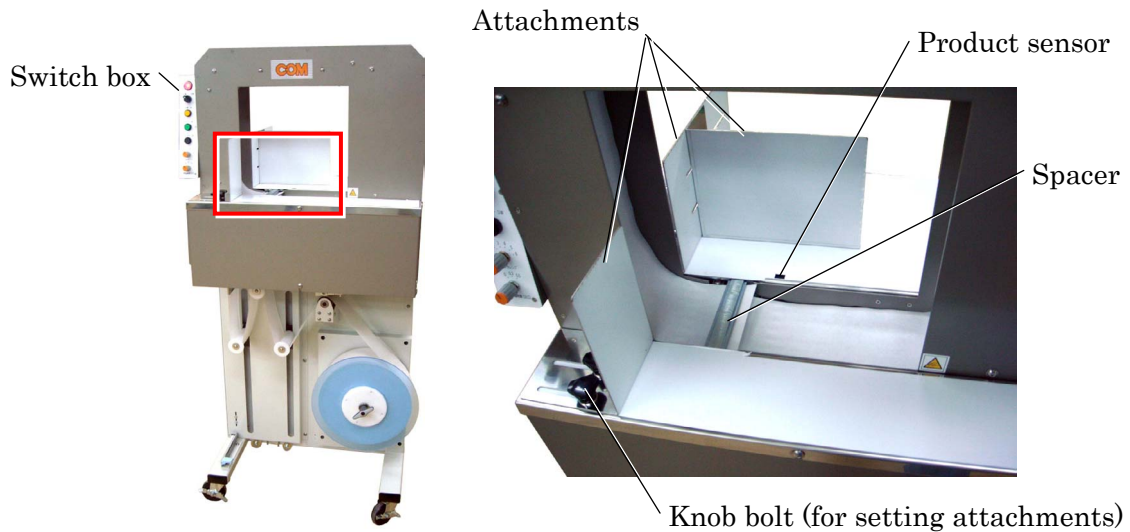

3-5-1.MAN mode (manual banding)

1. Making sure that the RUN lamp is lighting and tape setting has been completed, set the mode selector to MAN.
2. Place the product pressing it to the attachments.
3. Press the MAN switch or treadle the foot switch. The tape will be tensioned and it is cut when it is heat-sealed.
4. Remove the banded product. The tape will be then fed into the machine for next cycling.

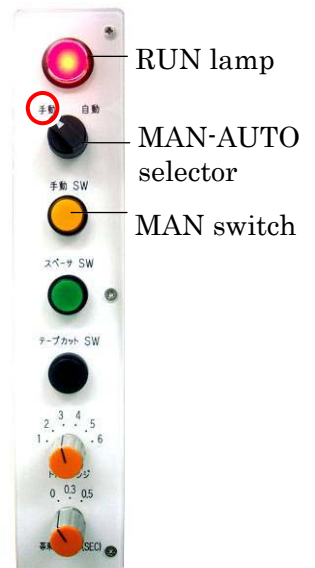

3-5-2.AUTO mode (automatic banding)

1. Making sure that the RUN lamp is lighting and tape setting has been completed, set the mode selector to AUTO.
2. Place the product pressing it to the attachments. The product sensor will detect the product and banding will be completed.
3. Remove the banded product. The tape will be then fed into the machine for next cycling.

Switch box



4. Alarm signal

When an alarming in the machine is detected, the alarm signal will be outputted.

The RUN lamp will flicker for stopping machine cycling.

Check the alarm detail by counting the frequency of flickering.

Alarm details are listed in the following table:

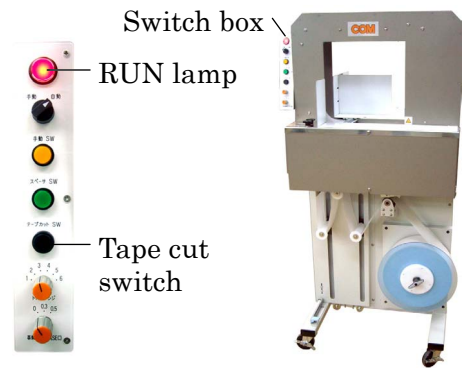

Frequency of flickering	Alarm signal	Details
Once	Heater start-up alarm	Heater temperature cannot rise to the preset level after the power is supplied.
Two times	Heater temperature alarm	Heater cannot keep the preset level.
Three times	Cam motor alarm	Cam motor is not fair.
Four times	Tape reel motor alarm	Tape reel motor is not fair.
	Tape brake alarm	Tape brake is not fair. *There may be a case that this signal is outputted when the tape is runout completely. Set a new tape reel after pressing the tape cut switch for clearing this alarm signal. (Refer to P.7 3-2. Tape setting)
Five times	Roller servo motor alarm	Servo motor is not fair.
Six times	Spacer motor alarm	Spacer motor is not fair.

* These alarm signals will be released by pressing the tape cut switch. . If the situation cannot be improved, please contact your local agent.

5. Specifications

Taping speed	WAS-250-75/100/150 22 cycles/minute WAS-400-75/100/150 22 cycles/minute
Capability(mm)	WAS-250-75/100/150 W 250×H 270 (max.) W 50×H 50 (min.) WAS-400-75/100/150 W 400×H 270 (max.) W 50×H 50 (min.)
Power supply	AC220V/230V 50/60Hz
Power consumption	500W
Ambient conditions	Room temp. 0–30 deg. C, humidity 85 % RH max.
Sealing system	Heater sealing (heater startup about 30 sec. after supplying power.)
Machine dimensions(mm)	WAS-250-75/100 W614×D465×H1292 (table height 926) WAS-250-150 W614×D565×H1292 (table height 926) WAS-400-75/100 W681×D465×H1292 (table height 926) WAS-400-150 W681×D565×H1292 (table height 926)
Machine weight	WAS-250-75/100/150 84kg WAS-400-75/100/150 87kg

WARRANTY

Taiyo Seiki Co., Ltd. warrants its products to be free from defects in material and workmanship for a period of six months from the date of shipping invoice, provided Taiyo Seiki approves the size workpiece and application of the supplied products.

Within the warranty period, Taiyo Seiki will repair or replace such products which are returned to it with shipping charges prepaid and which are disclosed as defective upon examination by Taiyo Seiki.

This warranty will not apply to any product which has been subject to misuse, negligence or accident, or use not in accordance with Taiyo Seiki's instruction or authorized agent or employees of Taiyo Seiki. The provisions of the warranty are the sole obligations of Taiyo Seiki and exclude all other warranties expressed or implied, including any warranties of merchantability. There are no warranties which extend beyond this warranty.

Taiyo Seiki shall not be liable for any consequential damages, either in law or in equity, or for losses or expenses or claims for the same arising from the use of or inability of use, the products of Taiyo Seiki for any purpose whatsoever.

Warranty becomes void if any alteration or deletion is made on any product of Taiyo Seiki's name, trademark, patent and or serial numbers. Taiyo Seiki's continuing commitment to product improvements will make specifications subject to change without notice.

This warranty is governed by the laws of Japan.



TAIYO SEIKI CO.,LTD.

4-3-7, Hino, Daitoh, Osaka, 574-0062, Japan.

Phone: 81-72-873-3739 Fax: 81-72-875-4324

URL: <http://www.com-machine.co.jp>

E-mail: taiyo@com-machine.co.jp

PRINTED IN JAPAN

3-100416